

SMS1040 Series Ultra-high current SMD power inductors

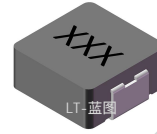

◆特征:

- 低直流电阻和超大电流的薄型设计
- 磁屏蔽型抗电磁干扰强适用于高密度安装
- 高可靠性, 通过采用一体成型结构享有卓越的抗震动性
- 由于复合结构, 超低蜂鸣噪声
- 低损耗合金粉末压铸低阻抗, 小寄生电容
- 能效高, 可减少绕线的低直流电阻与磁芯的涡流损耗
- 频率高达 3MHz
- 绝缘最大电压 30VDC
- 符合 RoHS, 无卤和 REACH

Features:

- Low RDC and ultra-high current thin design
- Magnetic shielding type, strong anti- electromagnetic Interference, suitable for high- density installation
- High-reliability, High vibration resistance as result of newly developed integral construction
- Ultra Low buzz noise, due to composite construction
- Die-casting by low loss alloy powder low impedance, Small parasitic capacitance
- High efficiency Low DC resistance of winding and low eddy-current loss of the core
- Frequency up to 3MHz
- Absolute maximum voltage 30VDC
- RoHS, Halogen Free and REACH Compliance

◆用途:

- PDA, 笔记本, 台式机, 服务器应用程序
- 大电流 POL 转换器
- 电池供电设备
- 分布式电源系统中的 DC/DC 转换器

Applications:

- PDA , notebook ,desktop ,server applications
- High current POL converters
- Battery powered devices
- DC/DC converters in distributed power systems

◆环境:

- 工作温度: -55℃ 至+125℃
(包括线圈自身温升)

Environmental Data:

- Operating Temperature: -55℃ to +125℃
(Including coils self-temperature rise)

◆试验设备:

- 电感值: WK3260B 或同等仪器
- 电流: WK3260B+WK3265B 或同等仪器
- 直流电阻: Chroma 16502 或同等仪器

Test Equipment:

- L: WK3260B LCR meter or equivalent
- Isat & Irms: WK3260B+WK3265B or equivalent
- DCR: Chroma 16502 or equivalent

◆产品型号:

Product Identification:

SMS

①

1040

②

470

③

M

④

I

⑤

①

类型 Type	
SMS	成型贴片功率电感 Molding SMD Power Inductor 

②

外形尺寸(L×W×H) (mm) External Dimensions (L×W×H) (mm)	
1040	11.5×10.0×4.0

③

Inductance
47 uH

④

公差 Inductance Tolerance
J:±5%,K: ±10%, L: ±15%
M: ±20%,P: ±25%, N: ±30%

⑤

包装 Packing	
B	散装Bulk Package
T	编带Tape & Reel

◆外观尺寸:

Shape and Dimensions(dimensions are in mm):

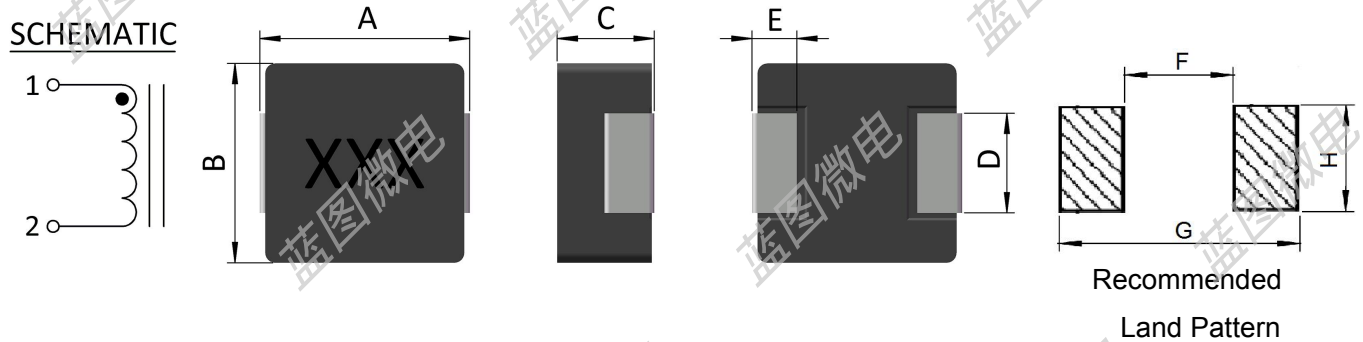

Part No	ITEM							
	A	B	C	D	E	F	G	H
SMS1040	11.50 Max	10.00±0.30	4.00Max	3.00 Typ	2.00 Typ	4.10	13.60	5.40

◆规格特性:

Specifications:

● SMS1040 Series Electrical Characteristics (Electrical specifications at 25°C)

Part No	Inductance 100KHz 1.0V		DCR (mΩ)		Saturation Current	Heat Rating Current
	L(μH) '@0A	Tol	Typical	Max	(A) Typical	(A) Typical
SMS1040-R22M	0.22	±20%	1.2	1.5	60.00	35.00
SMS1040-R36M	0.36	±20%	1.7	1.9	50.00	30.00
SMS1040-R47M	0.47	±20%	1.9	2.2	40.00	30.00
SMS1040-R56M	0.56	±20%	2.1	2.4	33.00	25.00
SMS1040-R68M	0.68	±20%	2.3	3.0	30.00	23.00
SMS1040-1R0M	1.0	±20%	3.0	4.0	28.00	18.00
SMS1040-1R5M	1.5	±20%	4.8	5.4	23.00	16.00
SMS1040-2R2M	2.2	±20%	7.2	9.0	18.00	12.00
SMS1040-3R3M	3.3	±20%	10.8	11.8	16.00	10.00
SMS1040-4R7M	4.7	±20%	17.0	20.0	15.00	8.50
SMS1040-5R6M	5.6	±20%	20.5	23.0	13.00	8.00
SMS1040-6R8M	6.8	±20%	22.5	25.0	12.00	7.00
SMS1040-100M	10	±20%	34.0	37.0	8.50	5.50
SMS1040-150M	15	±20%	50.0	55.0	7.00	5.00
SMS1040-220M	22	±20%	60.0	66.0	6.00	4.00

Part No	Inductance 100KHz 1.0V		DCR (mΩ)		Saturation Current	Heat Rating Current
	L(μH) '@0A	Tol	Typical	Max	(A) Typical	(A) Typical
SMS1040-330M	33	±20%	85.0	92.0	5.00	3.50
SMS1040-470M	47	±20%	141.0	155.0	4.50	3.00
SMS1040-680M	68	±20%	200.0	220.0	3.80	2.30
SMS1040-101M	100	±20%	237.0	290.0	3.00	2.00

- Saturation Current: DC current at which inductance drops 30% from its value without current.
- Heat Rating Current: the actual value of DC current when the temperature rise is ΔT 40°C ($T_a=25^\circ\text{C}$).
- Rated DC Current: The less value which is Isat or Irms.
- Special remind: Circuit design, component, PCB trace size and thickness, airflow and other cooling provisions all affect the part temperature. Part temperature should be verified in the end application.
- Saturation current VS temperature rise current curve

SMS1040-R22M

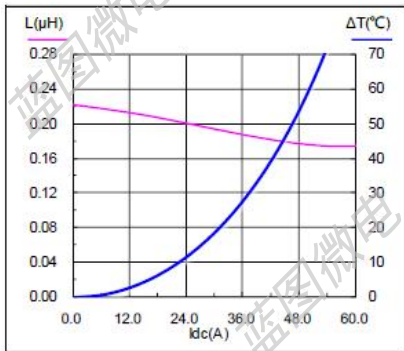

SMS1040-R36M

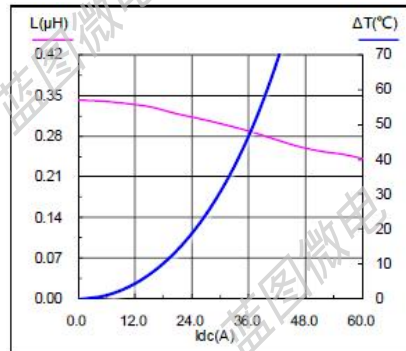

SMS1040-R47M

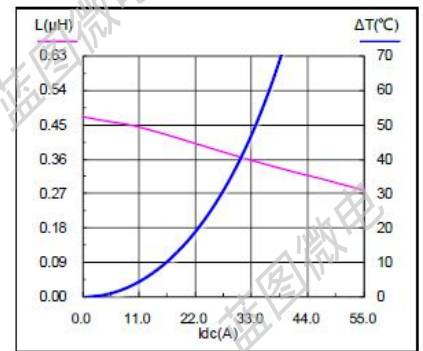

SMS1040-R56M

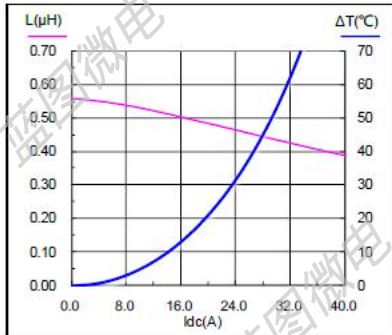

SMS1040-R68M

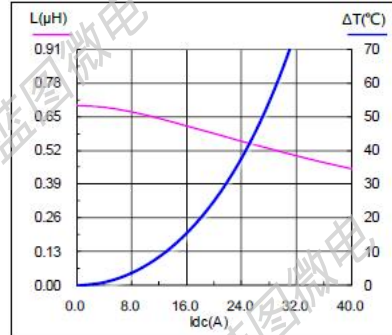

SMS1040-1R0M

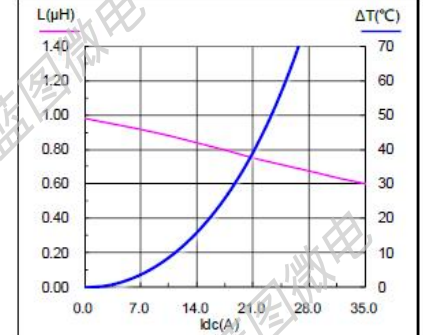

SMS1040-1R5M

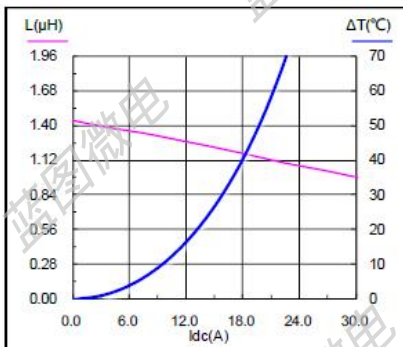

SMS1040-2R2M

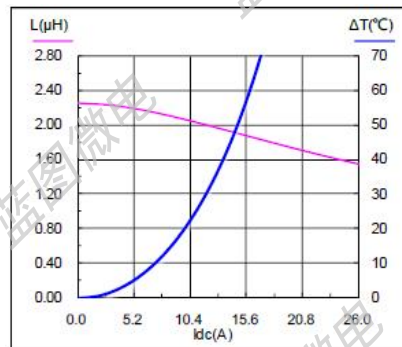

SMS1040-3R3M

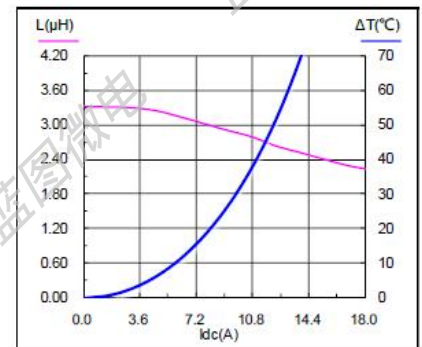

SMS1040-4R7M

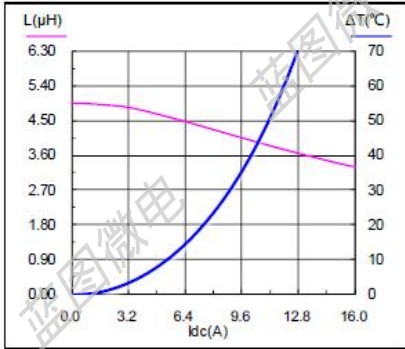

SMS1040-5R6M

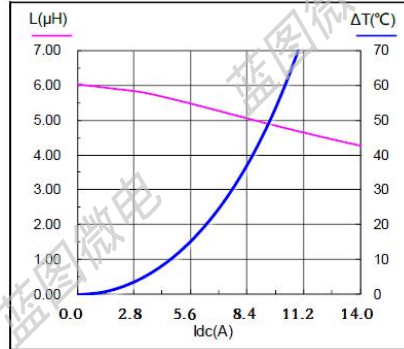

SMS1040-6R8M

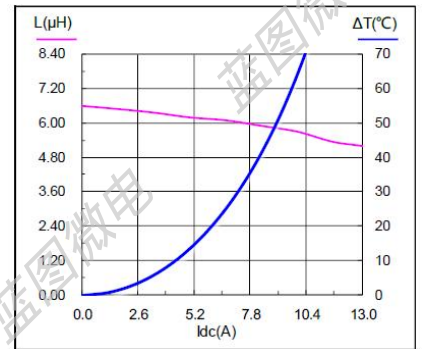

SMS1040-100M

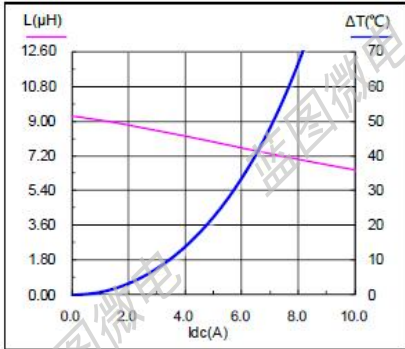

SMS1040-150M

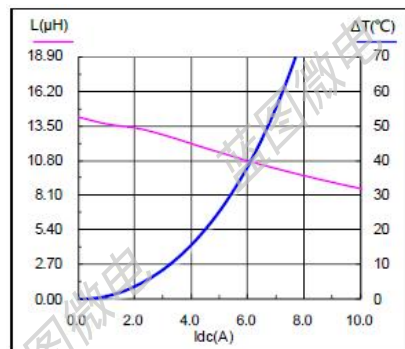

SMS1040-220M

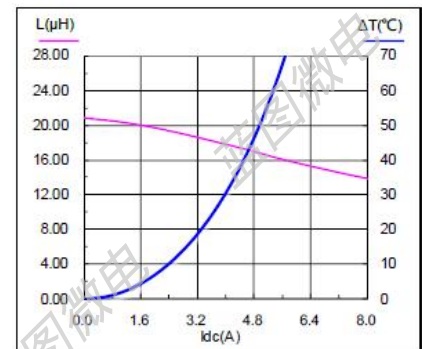

SMS1040-330M

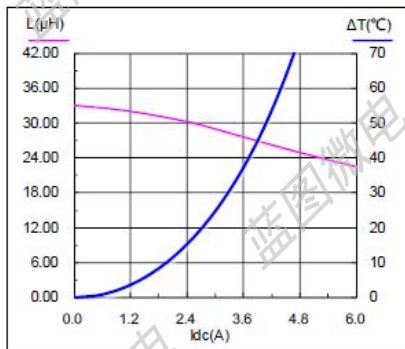

SMS1040-470M

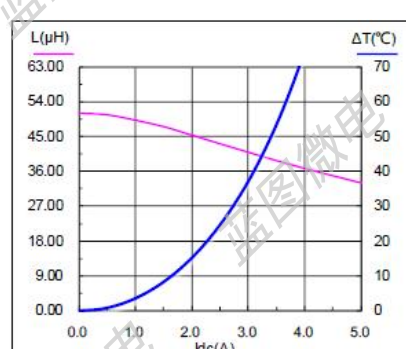

SMS1040-680M

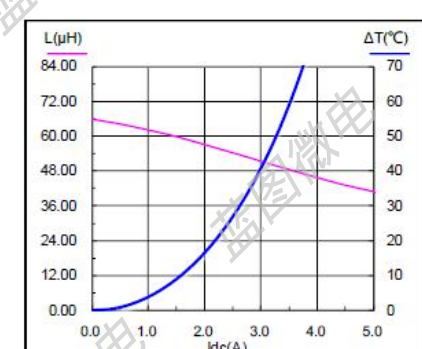

SMS1040-101M

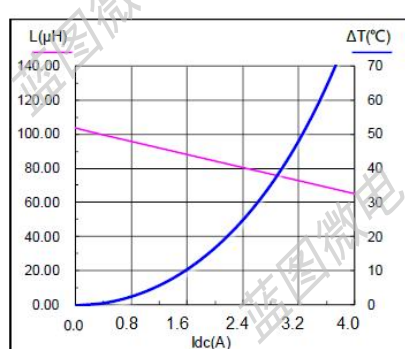

◆ 产品包装: Packaging:

● Tape and Reel Specifications: (Dimensions are in mm)

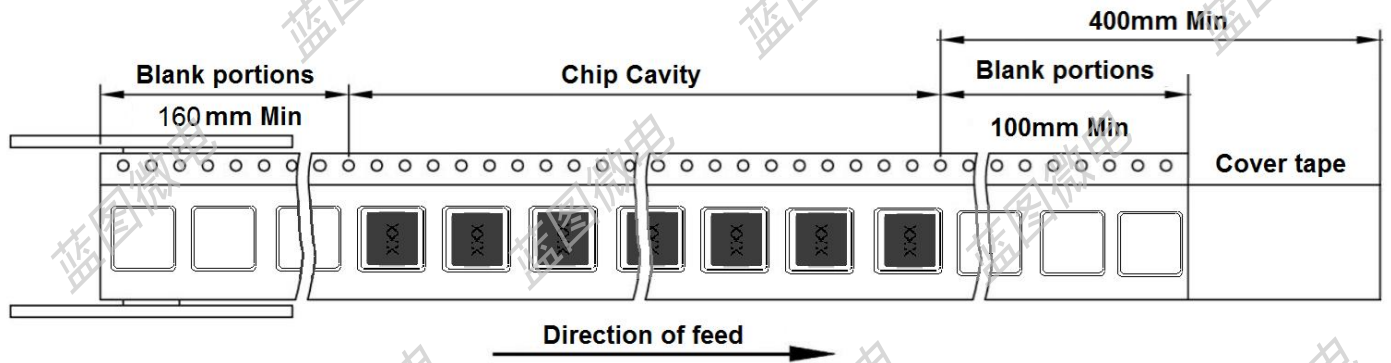

● Reel dimensions (mm)

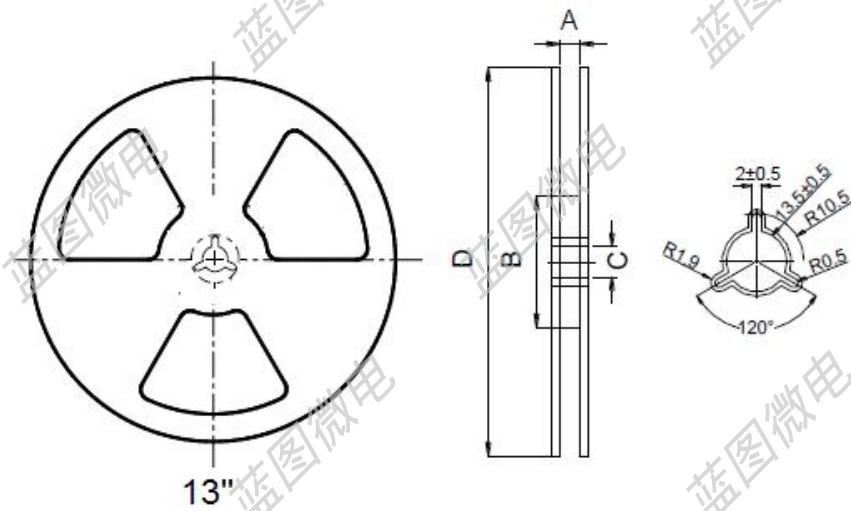

● Tape Dimension (mm)

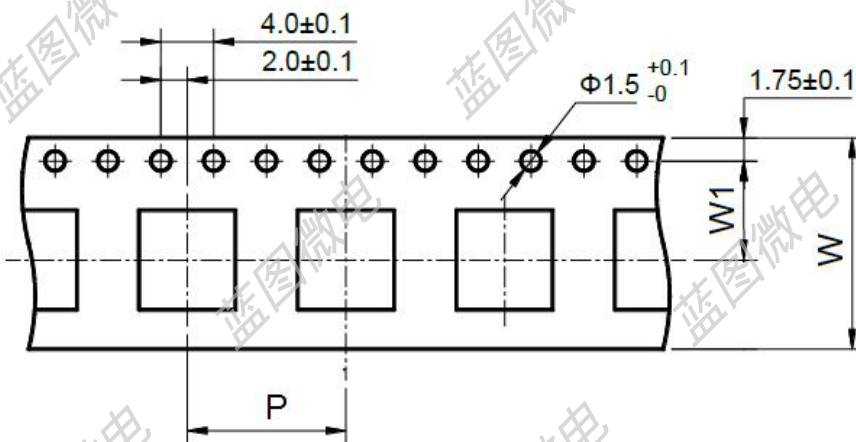

Part No.	Tape Dimension			Reel Dimensions				REEL (PCS)	Inside Box(PCS)	Outside Carton(PCS)
	W	P	W1	A	B	C	D			
SMS1040	24.0	16.0	11.5	24.4	100	13	330	1000	2000	8000

• Cover tape peel off condition

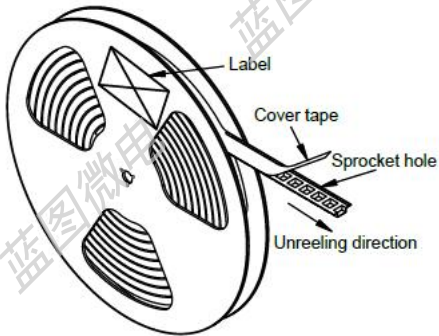

- a) Cover tape peel force shall be 10 to 120g
- b) Noodle strip peeling angle 165° to 180°

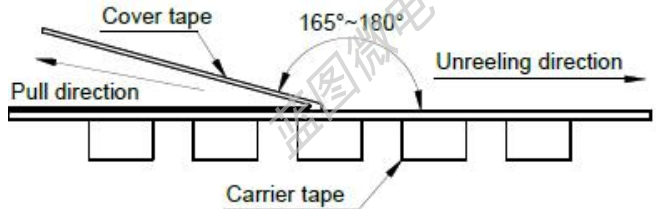

• Packing quantity

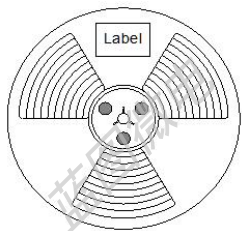

REEL 13

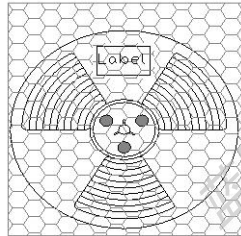

PE 袋

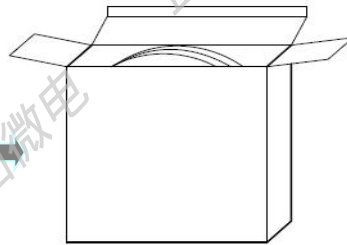

Inside Box

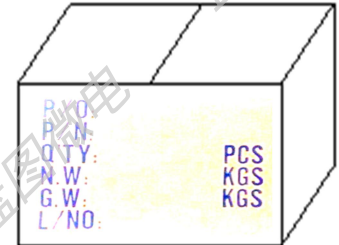



Outside Carton.

不足整箱用内盒或填充物装满

◆可靠性测试:

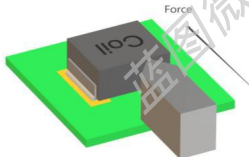
Reliability Testing:

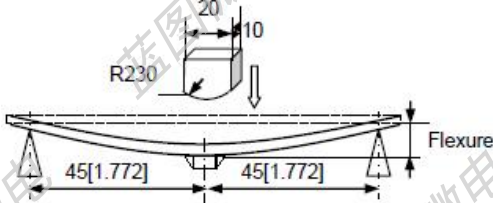
Items	Requirements	Test Methods and Remarks
Terminal Strength Reference documents: GB/T 2423.60-2008 端子强度(SMT)	1. Pulling test: Define: A: sectional area of terminal $A \geq 8\text{mm}^2$ force $\geq 5\text{N}$ time: 30sec $8\text{mm}^2 < A \leq 20\text{mm}^2$ force $\geq 10\text{N}$ time: 10sec $20\text{mm}^2 < A$ force $\geq 20\text{N}$ time: 10sec 2. Solder paste thickness: 0.12mm 3. Meet the above requirements without any loose terminal	Solder the inductor to the testing jig using leadfree solder. Then apply a force in the Keep time: $10 \pm 1\text{s}$ Speed: 1.0mm/s. 
Terminal Strength Reference documents: GB/T 2423.60-2008 端子强度(DIP)	1. Terminal diameter(d) mm $0.35 < d \leq 0.50$ Applied force: 5N Duration: 10sec 2. Terminal diameter(d) mm $0.50 < d \leq 0.80$ Applied force: 10N Duration: 10sec 3. Terminal diameter(d) mm $0.80 < d \leq 1.25$ Applied force: 20N Duration: 10sec 4. Terminal diameter(d) mm $D > 1.25$ Applied force: 40N Duration: 10sec 5. Meet the above requirements without any loose terminal.	Pull Force: the force shall be applied gradually to the terminal and then maintained for 10 seconds. 
Resistance to Flexure JIS C 5321:1997 抗弯曲性试验	1. No visible mechanical damage.	1. Solder the inductor to the test jig (glass epoxy board) 2. shown in Using a leadfree solder. Then apply a force in the direction shown 3. Flexure: 2mm. 4. Pressurizing Speed: 0.5mm/sec. 5. Keep time: 30 sec. 
Dropping Reference documents: GB/T 2423.7-2018 落下试验	1. No case deformation or change in appearance. 2. No short and no open.	1. Drop the packaged products from 1m high in 1 angle, 3 ridges and 6 surfaces, twice in each direction.
Solderability Reference documents: GB/T 2423.28-2005 可焊性试验	1. No visible mechanical damage. 2. Wetting shall exceed 75% coverage for 3. Terminals must have 95% minimum solder coverage	1. Solder temperature: $240 \pm 2^\circ\text{C}$ 2. Duration: 3 sec. 3. Solder: Sn/3.0Ag/0.5Cu. 4. Flux: 25% Resin and 75% ethanol in weight

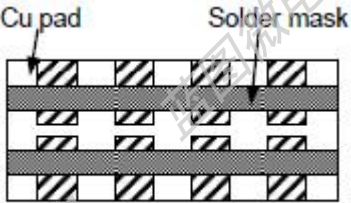
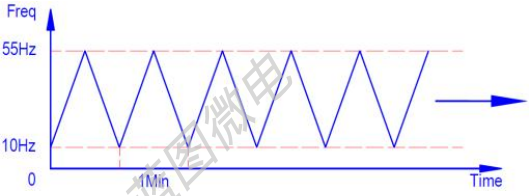
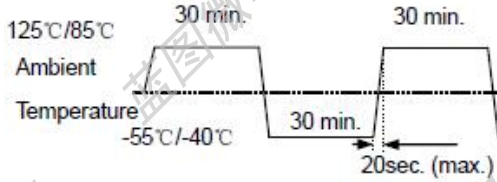
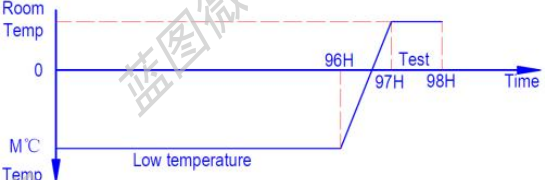
Items	Requirements	Test Methods and Remarks
<p>Vibration</p> <p>Reference documents: GB/T 2423.10-2019</p> <p>振動試驗</p>	<p>1.No visible mechanical damage.</p> <p>2. Inductance change: Within $\pm 10\%$.</p> <p>3.Q factor change: Within $\pm 20\%$.</p>  <p style="text-align: center;">Glass Epoxy Board</p>	<p>1.Solder the inductor to the testing jig (glass epoxy board shown in) using leadfree solder.</p> <p>2.The inductor shall be subjected to a simple harmonic motion having total amplitude of 1.5mm, the frequency being varied uniformly between the approximate limits of 10 and 55 Hz.</p> <p>3.The frequency range from 10 to 55 Hz and return to 10 Hz shall be traversed in approximately 1 minute. This motion shall be applied for a period of 2 hours in each 3 mutually perpendicular directions (total of 6 hours).</p> 
<p>Thermal Shock</p> <p>Reference documents: GB/T 2423.22-2012</p> <p>Method Na</p> <p>冷热冲击试验</p>	<p>1.No visible mechanical damage.</p> <p>2. Inductance change: Within $\pm 10\%$. (Mn-Zn: Within $\cong 30\%$)</p> <p>3.Q factor change: Within $\pm 20\%$.</p>	<p>1.Start at (85~125℃) for T time, rush to (-55~-40℃) for T time as one cycle, go through 100 cycles.</p> <p>2.Transforming interval: Max. 20 sec.</p> <p>3.Tested cycle: 100 cycles.</p> <p>4.The chip shall be stabilized at normal condition for 1~2 hours</p> 
<p>Low temperature Storage</p> <p>Reference documents: GB/T 2423.1-2008</p> <p>Method Ab</p> <p>低温储存试验</p>	<p>1.No visible mechanical damage.</p> <p>2. Inductance change: Within $\pm 10\%$. (Mn-Zn: Within $\cong 30\%$)</p> <p>3.Q factor change: Within $\pm 20\%$.</p>	<p>1.Temperature: M(-55~-40± 2℃)</p> <p>2.Duration: 96± 2 hours</p> <p>3.The chip shall be stabilized at normal condition for 1~2 hours before measuring.</p> 

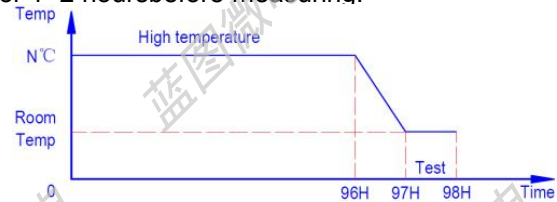
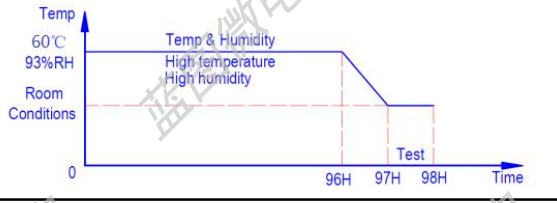
Items	Requirements	Test Methods and Remarks
High temperature Storage Reference documents: GB/T 2423.2-2008 Method Bb 高温储存试验	1.No visible mechanical damage. 2. Inductance change: Within $\pm 10\%$.(Mn-Zn: Within $\leq 30\%$) 3.Q factor change: Within $\pm 20\%$.	1.Temperature:N($125\sim 85\pm 2^{\circ}\text{C}$). 2.Duration: 96 ± 2 hours 3.The chip shall be stabilized at normal condition for 1~2 hours before measuring. 
Damp Heat (Steady States) Reference documents: GB/T 2423.3-2016 恒定湿热试验	1.No visible mechanical damage. 2. Inductance change: Within $\pm 10\%$.(Mn-Zn: Within $\leq 30\%$) 3.Q factor change: Within $\pm 20\%$.	1.Temperature: $60\pm 2^{\circ}\text{C}$ 2.Humidity: 90% to 95% RH. 3.Duration: 96 ± 2 hours. 4.The chip shall be stabilized at normal condition for 1~2 hours before measuring. 
Heat endurance of Reflow soldering Reference documents: GJB 360B-2009 回流焊耐热性试验	1.No significant defects in appearance. 2. $\Delta L/L \leq 10\%$ (Mn-Zn: $\Delta L/L \leq 30\%$) 3. $\Delta Q/Q \leq 30\%$ (SMD series only) 4. $\Delta DCR/DCR \leq 10\%$	1.Refer to the above reflow curve and go through the reflow for twice. 2.The peak temperature : $260\pm 0/-5^{\circ}\text{C}$
Resistance to solvent test Reference documents: IEC 68-2-45:1993 耐溶剂性试验	No case deformation or change in appearance or obliteration of marking	To dip parts into IPA solvent for 5 ± 0.5 Min,then drying them at room temp for 5Min,at last ,to brushing making 10 times.
Overload test Reference documents: JIS C5311-6.13 过负荷试验	1.During the test no smoke, no peculiar, smell, no fire 2.The characteristic is normal after test	Apply twice as rated current for 5 minutes.
voltage resistance test Reference documents: MIL-STD-202G Method 301 绝缘耐压测试	1.During the test no breakdown 2.The characteristic is normal after test	1. For parts with two coils 2. DC1000V, Current: 1mA, Time: 1Min. 3. Refer to catalogue of specific products

◆ 推荐回流焊温度曲线

Recommended reflow soldering curve:

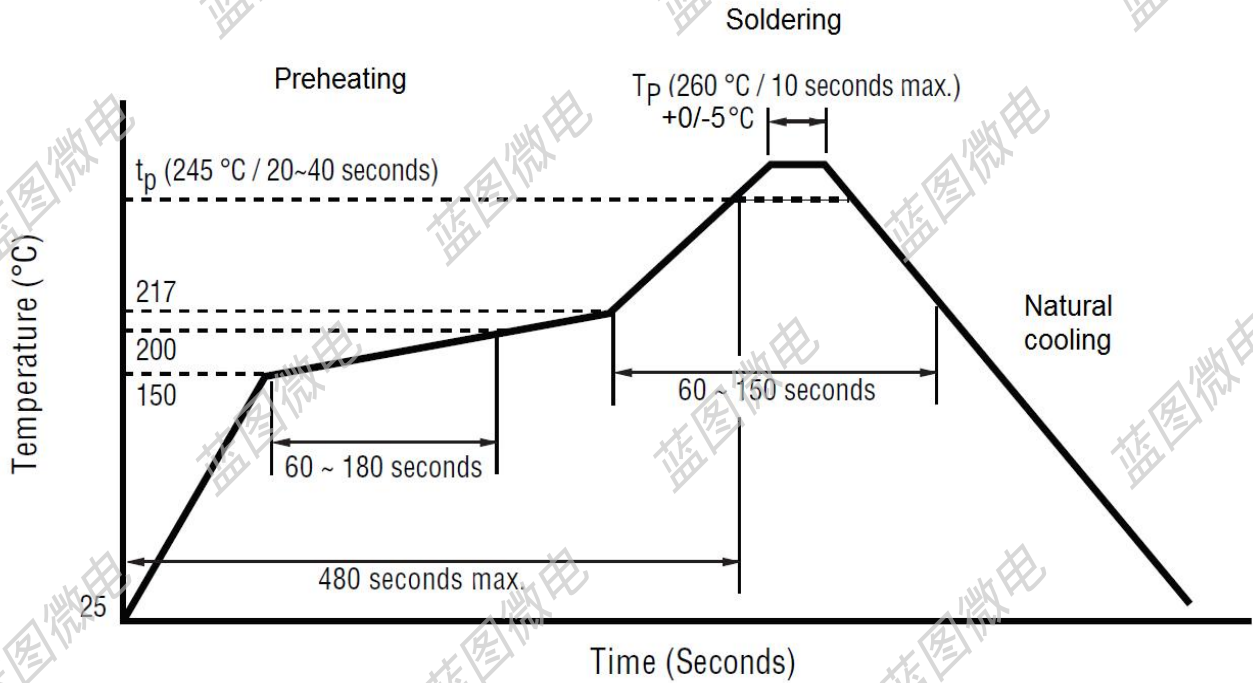

The recommended reflow conditions as above graph, is set according to our soldering equipment. DUE to various manufactures may have different reflow soldering equipment, products, process conditions, set methods. And so on, when setting the reflow conditions, Please adjust and confirm according to users' environment/equipment.

使用注意事项

REMINDERS FOR USING THESE PRODUCTS



- 保存时间为12个月以内，保存条件（温度5~40°C以下、湿度35 ~ 66%RH 以下），需充分注意。若超过保存时间，端子电极的可焊性将可能老化。

The storage period is within 12 months. Be sure to follow the storage conditions (temperature: 5~40°C, humidity: 35 to 65% RH or less). If the storage period elapses, the soldering of the terminal electrodes may deteriorate.

- 请勿在气体腐蚀环境（盐、酸、碱等）下使用和保存。

Do not use or store in locations where there are conditions such as gas corrosion (salt, acid, alkali, etc.).

- 手上的油脂会导致可焊性降低，应避免用手直接接触端子。

Don't touch electrodes directly with bare hands as oil secretions may inhibit soldering. Always ensure optimum conditions for soldering.

- 请小心轻拿轻放，避免由于产品的跌落或取出不当而导致的损坏。

Please always handle products carefully to prevent any damage caused by dropping down or inappropriate removing.

- 端子过度弯曲会导致断线，请不要过度弯曲端子。

Don't bend the terminals with excessive stress in case of any wire fracture.

- 不要清洗产品，如需要清洗时请联系我司。

Don't rinse coils by yourself and please contact SXN if necessary.

- 请勿将本产品靠近磁铁或带有磁力的物体

Don't expose the products to magnets or magnetic fields

- 在实施焊接前，请务必进行预热。预热温度与焊接温度及芯片温度的温度差要在150°C 以内。

Before soldering, be sure to preheat components. The preheating temperature should be set so that the temperature difference between the solder temperature and chip temperature does not exceed 150°C.

- 安装后的焊接修正应在规格书规定的条件范围内。若加热过度可能导致短路、性能降低、寿命减少。

Soldering corrections after mounting should be within the range of the conditions determined in the specifications. If overheated, a short circuit, performance deterioration, or lifespan shortening may occur.

- 装置会因通电而自我发热（温度上升），因此在热设计方面需留有充分余地。

Self heating (temperature increase) occurs when the power is turned ON, so the tolerance should be sufficient for the set thermal design.

- 非磁屏蔽型在基板设计时需注意配置线圈，受到电磁干扰可能会导致误动作。

Carefully lay out the coil for the circuit board design of the non-magnetic shield type. A malfunction may occur due to magnetic interference.